

S3i CONTROLLER HANDHELD STATIC DIMMER



Product Code: NF-S3i-WC-D

Features

- Single color controller
- Controls 6 zones
- High sensitive touch wheel
- 5 year warranty
- Fast and precise color
- Smart, simple, seamless integration



Data

Output Signal	RF Signal
Operation Frequency	869.5 / 916.5 / 434MHz
Power Supply	3 AAA Batteries (included)
Operating Temperature	32° - 104° F
Relative Humidity	8 - 80%
Wireless Range	50 ft

Dimensions

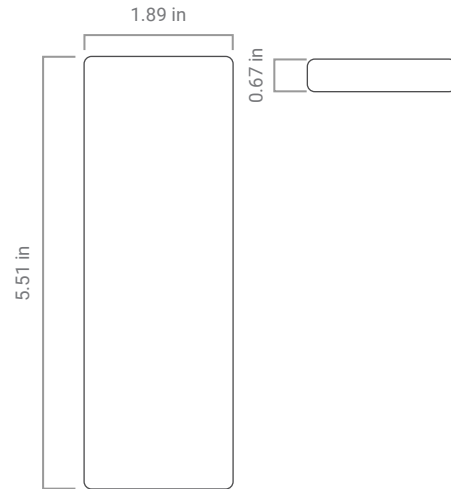

S3i WIRELESS RECEIVER

Product Code: NF-S3i-WR-1009

Use one receiver per zone, up to 6 zones depending on the controller selected. Pair with [NF-A-UNV](#) for large projects.



Data

Input Voltage	12 - 36 VDC
Output Current	4 x 5 A
Output Power	240 - 720W

Dimensions

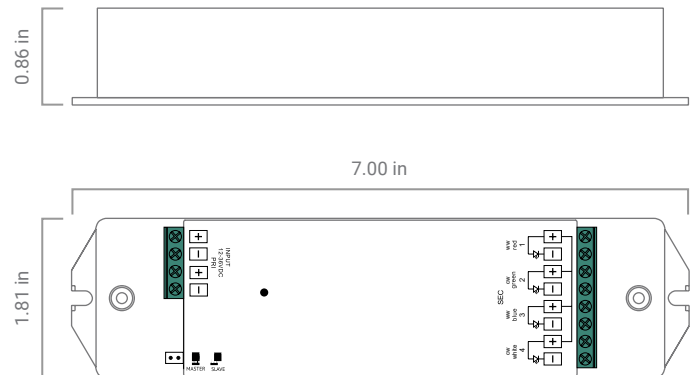

INSTALLATION HANDHELD STATIC DIMMER

Installation

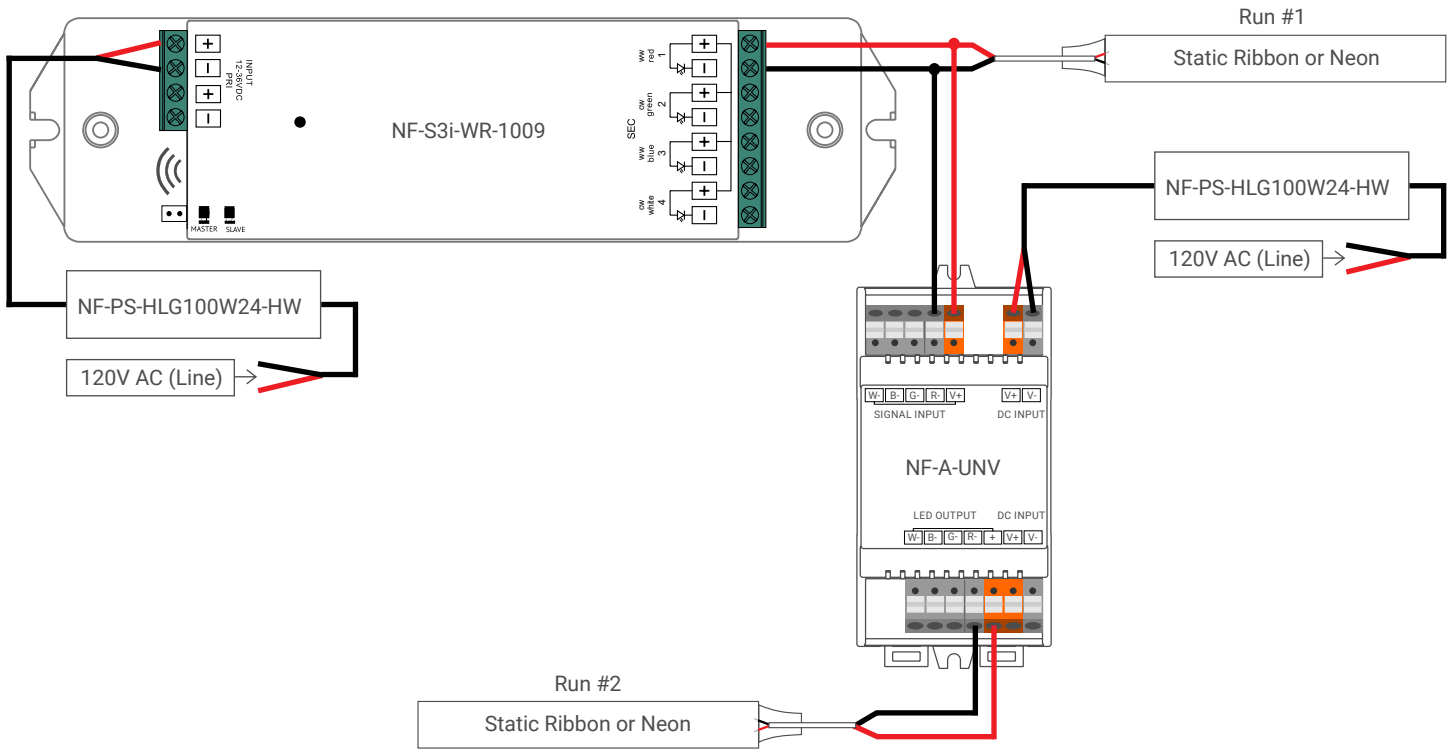

Pairing

Turn on the remote by pressing power button , Red LED Indicator Light in right hand corner will illuminate.

Click Learning Key on the NF-S3i-WR-1009

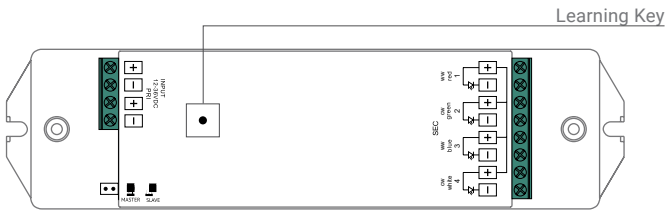

Click your "ZONE" (# 1-6 on bottom of remote) you would like to pair with, then move finger around the color wheel.

Lights will flash once indicating zone is paired.

Repeat process as needed.

You can pair multiple NF-S3i-WR-1009 to the same zone following the process above.

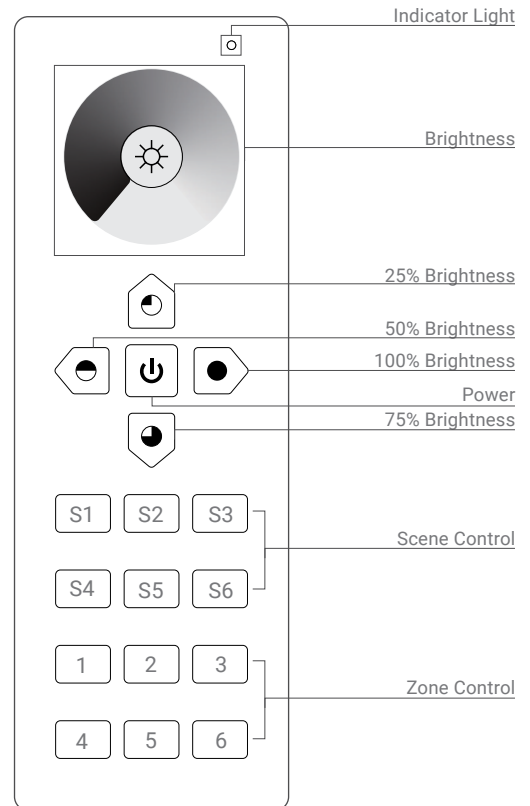

SET-UP HANDHELD STATIC DIMMER

Operation

Controlling Zones – Up to (6) different ZONES

Once zone is paired, turn on the remote and select the “ZONE” you’d like to control.

Controlling MULTIPLE ZONES at once is easy by selecting ALL ZONES in continuous form that you want to control. Ex: to control 1, 3, and 4, click **1, 3, 4**, one after another then move finger on color wheel . All zones 1, 3, 4 are now being controlled at the same time.

To get OFF this mode, simply select a specified ZONE after a few seconds you’d like to control.

Turn ON/OFF a single Zone

Press and hold ZONE number you’d like to turn ON/OFF.

Setting Scenes – Up to 6 different SCENES total





Turn on the remote. Select your “ZONE” you’d like to control. Once your ZONE is on the color of preference, press and hold “SCENE” number for 3 Seconds (lights should flash when stored successfully).

To change SCENES to multiple zones, select ALL ZONES in continuous form that you’d like to control. Then select the SCENE.

Adjusting Brightness

Select the ZONE(s) you’d like to control. Then control with Color Wheel  to the desired level of light.

Select the ZONE(s) you’d like to control. Press and hold  to adjust light level (release button and press and hold again to go opposite direction).

Select the ZONE(s) you’d like to control. Use “Preset Moons” buttons surrounding the power button to automatically go to 25% light , 50% light , 75% light  and 100% light .

FOR MORE
INFORMATION
CLICK HERE 

PROJECT SUPPORT

INSTALLATION GUIDES

WHY NOVA FLEX

RESOURCES