

# 30W UNIVERSAL DIMMABLE DRIVER

NOVA FLEX®

Product Code: NF-PS-UNV-30W-24V

- Universal Dimming functions: 0-10V, 1-10V, potentiometer, 10V PWM, forward phase/leading edge/MLV and reverse phase/trailing edge/ELV TRIAC
- Can also be used in non-dimming configurations
- Works with static white, static color, adjustable, RGB, RGBW, and DRGB LED strip and neon
- Built-in active PFC (power factor correction)
- PWM output (pulse width modulation—doesn't change color index)
- DMX system compatible
- 0-10V dimming wires are capped and labeled to ensure they're only used when needed



## Input

Voltage Range	120 – 277VAC
Frequency Range	47 – 63Hz
AC Current (Max)	0.5A @ 100VAC
Inrush Current	7A 50% 420µs @ 120VAC 12A 50% 480µs @ 277VAC
Efficiency	79% @ 120VAC 80% @ 277VAC
Power Factor	0.99 @ 120VAC 0.95 @ 277VAC
THD	< 20%

## Environment

Protection Rating	cULus Listed, UL 8750, Class 2, Type HL rated, FCC
Operating Temp	-40° to 140° F (-40° to 60° C) See derating curve in this spec doc
Storage Temp	-40° to 176° F (-40° to 80° C)
Expected Life	50,000 Hrs
Audible Noise	< 24dBA
Housing	Full protection metal housing for dry, damp, or wet locations (IP 66)

## Protection

Over Temperature	212° ± 50° F shutdown o/p voltage, auto-recover after cooling
Over Load	≤ 120% shutdown o/p voltage, re-power to recover after fault condition removed
Short Circuit	Shutdown o/p voltage, re-power to recover after fault condition removed
Customer Warranty	2 - 5 years (based on warranty of LED strip/neon purchased)

## Output

Voltage	24 VDC
Power	30W
Current	1.25A
Voltage Tolerance	± 0.5V
Voltage Regulation	± 0.5%
Load Regulation	± 1%
Minimum Load	10% = 3W

## Dimming

Dimming Control	0-10V, 1-10V, potentiometer, 10V PWM, forward phase/leading edge/MLV and reverse phase/trailing edge/ELV TRIAC
Dimming Range Capability	0 - 100%, Flicker free (depends on dimmer type and specs)

## Dimensions & Weight

Length	5.94 in.
Mounting Length	6.5 in.
Width with Cover	3.72 in.
Height with Cover	1.57 in.
Weight	2.09 lbs

FOR MORE  
INFORMATION  
CLICK HERE



COMPATIBLE DIMMERS

INSTALLATION GUIDE

# UNIVERSAL DIMMABLE DRIVER

Product Code: NF-PS-UNV-30W-24V

## Notes

- This driver should be installed by a qualified professional
- If using potentiometer dimming, the resistor should be  $\geq 100\text{K}\Omega$ , otherwise dimming performance will be compromised
- Please make sure the driver is installed with adequate ventilation to allow for heat dissipation
- Contact an integrator to set up your DMX/DRGB configuration
- Ensure that wiring is correct in order to avoid light and power supply damage
- The purple and pink dimming wires are only for use with 0-10V, 1-10V, potentiometer and 10V PWM dimming configurations. They should be capped when not in use (see photo at right)

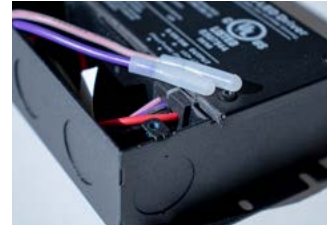

## Wiring Diagrams

### TRIAC / PHASE CUT DIMMING



- The Pulse-Width Modulation (PWM) for output voltage can be adjusted through input terminal of the AC phase line(L), by connecting a phase/ TRIAC dimmer
- Works with forward phase/leading edge, MLV and reverse phase/trailing edge, ELV, TRIAC dimmers
- Please use dimmers with power  $\geq 1.5$  times the output power of the driver

### 0-10V/1-10V DIMMING, WITH DIMMER ON INPUT SIDE

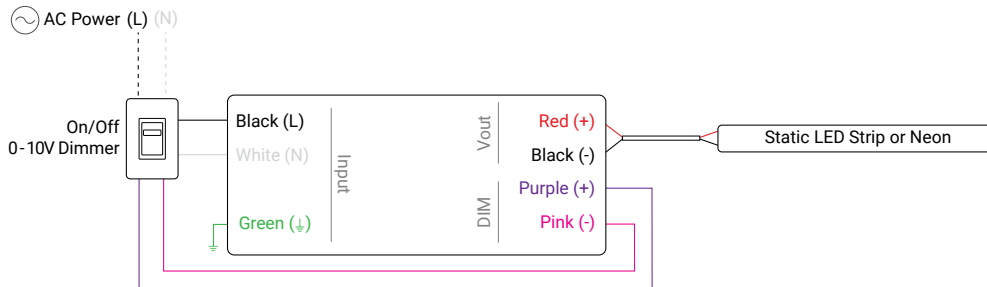

- The 0-10V/1-10V dimmer is on the input side so it can control dimming and on/off functions

### 0-10V/1-10V DIMMING, WITH ON/OFF SWITCH ON INPUT SIDE

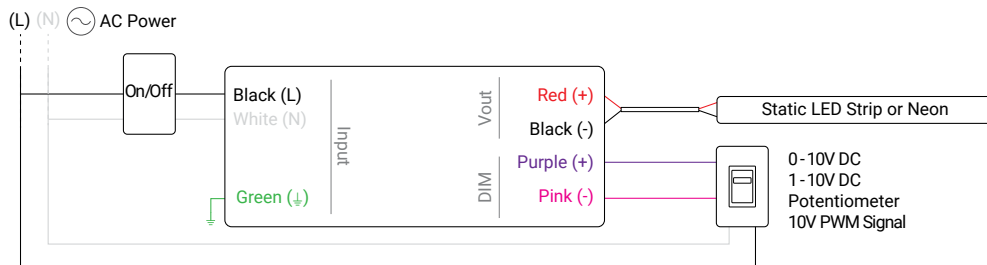

- The on/off switch is on the input side. 0-10V/1-10V controls dimming only, not on/off function

### NOVA FLEX STATIC DIMMER TOUCH PANEL CONTROL (NF-S3I-TP-D) AND WIRELESS RECEIVER (NF-S3I-WR-1009)

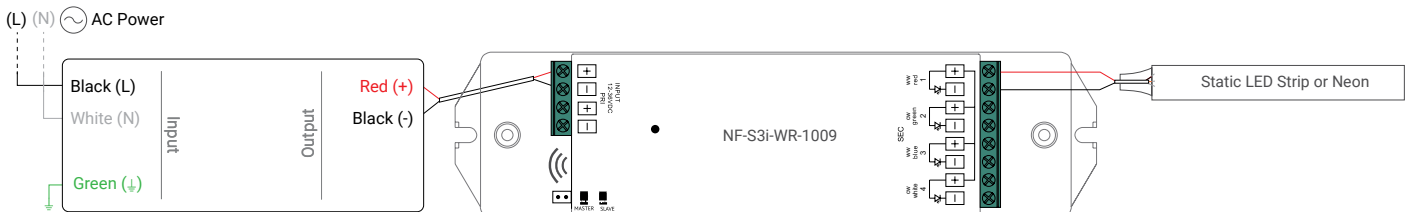

# UNIVERSAL DIMMABLE DRIVER

Product Code: NF-PS-UNV-30W-24V

## Wiring Diagrams

### NOVA FLEX ADJUSTABLE TOUCH PANEL CONTROL (NF-S3I-TP-AS) AND WIRELESS RECEIVER (NF-S3I-WR-1009)

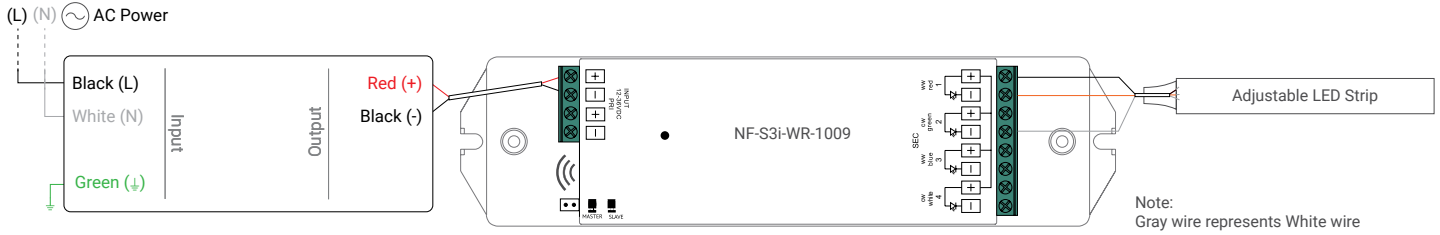

### NOVA FLEX RGB TOUCH PANEL CONTROL (NF-S3I-TP-RGB) AND WIRELESS RECEIVER (NF-S3I-WR-1009)

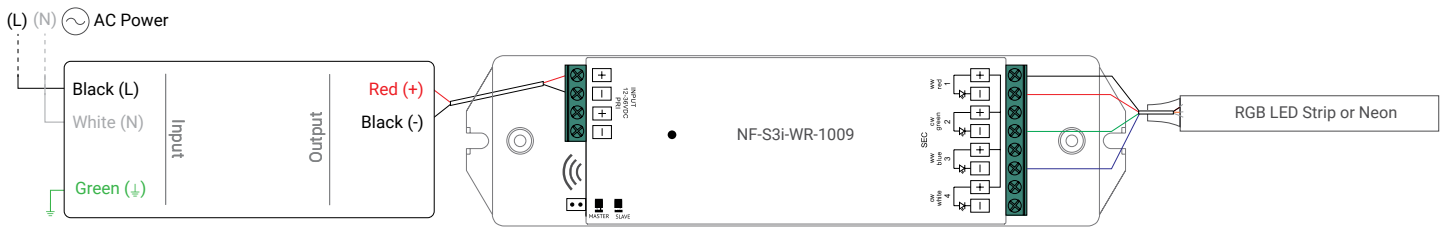

### NOVA FLEX RGBW TOUCH PANEL CONTROL (NF-S3I-TP-RGBW) AND WIRELESS RECEIVER (NF-S3I-WR-1009)

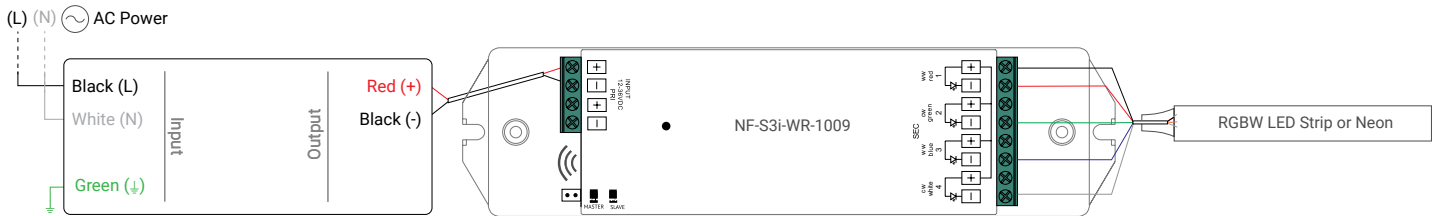

## Spec Drawing

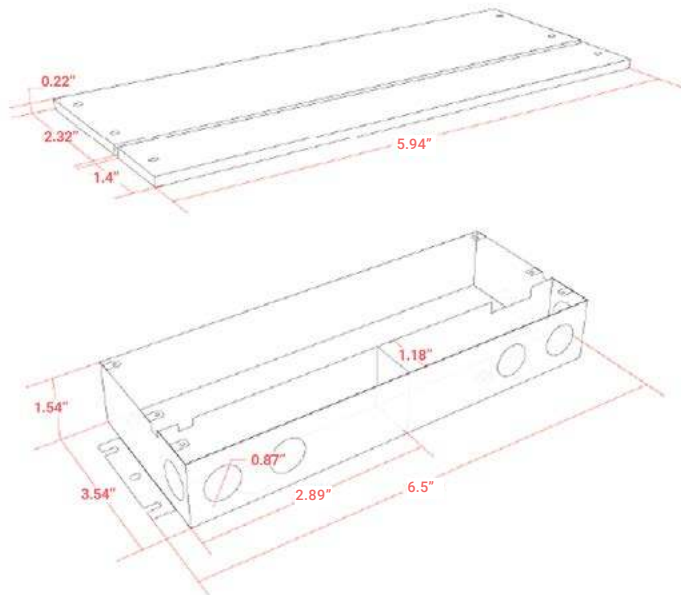

# UNIVERSAL DIMMABLE DRIVER

Product Code: NF-PS-UNV-30W-24V

## Derating Curve

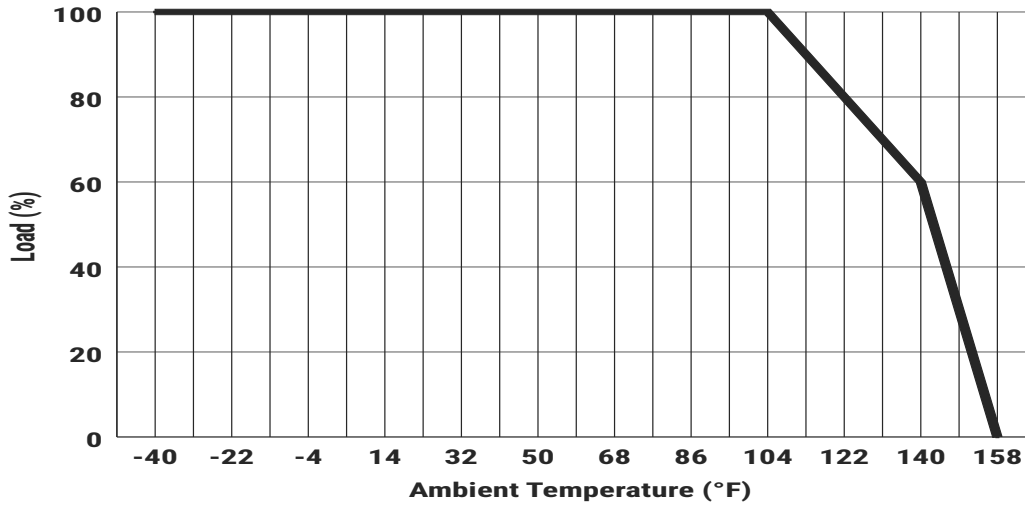

## Dimming Curves

Dimming curve: linear



Dimming curve: logarithmic

