

ColorFacade - Wall Grazing C-SS2-RGBW-18L-18

40" Adjustable RGBW Linear Flood/
Spot DMX Light

CAT. NO.: _____
TYPE: _____
PROJECT: _____



APPLICATION

For use as linear, direct flood and/or accent lighting, installed as an above grade fixture. Perfect for applications desiring a dynamic color changing effect. Recommended for retail, modern residential, hospitality and entertainment installations. RGBW design allows fine-tuned pastel colors and saturated hues without sacrificing illumination brightness. DMX control option allows the use of DMX512 Control Systems to individually control and change colors, set looks, and add lighting effects which can affect moods, feelings and atmosphere.

- 105W (16-LED) 5,250 Max. Lumen
- DMX direct via LCD display, Proprietary quick connectors included
- IP65
- 18° beam spread
- LED Die Colors: RGBW
- Using proprietary technology, colors are efficiently blended together through an internal mixing chamber. The one-color output reduces unsightly views of isolated rainbow like striations.
- Smooth and flicker-free dimming of all colors down to 1%
- 3 Year Warranty

DIMENSIONS

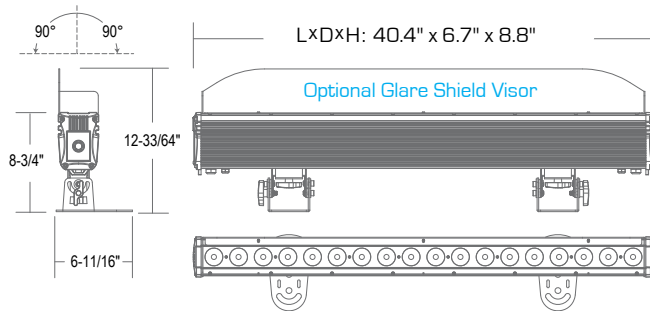

ACCESSORIES

Glare Shield Visor
To direct the light & reduce glare; if ordered, **the VSR will arrive installed on fixture.** C-P-SS2-18L-18-VSR

60" Plug-In Cord (in addition to cord included with unit) C-SWR-PWR-WL-60-PI

For connecting mains power to unit. Terminated in a 15A male Edison connector.



80" Power Jumper C-SWR-PWR-WL-80

For daisy chaining power from powered unit to unpowered unit. No more than 9 units max from main power feed.



300" (25') Data Cable Interconnect C-SWR-DMX-WL-300

For daisy chaining DMX from one fixture to another. Maximum 32 fixtures may be connected on any DMX run (for bare-end at one end, please specify -HW).



80" DMX/Data Jumper C-SWR-DMX-WL-80

For daisy chaining DMX from one fixture to another. Maximum 32 fixtures may be connected on any DMX run (for bare-end at one end, please specify -HW).



Wet Location Power End Caps (in addition to the set included with unit) C-PCL008-WL-PWR

Protective cover for use in wet location environments for capping power connector cable.



Wet Location DMX End Caps (in addition to the set included with unit) C-PCL008-WL-DMX

Protective cover for use in wet location environments to cap DMX cables. Not a DMX terminator.



120 ohm DMX Terminator (4-pin) C-PCL002-WL-DMX



2022.03.01

ColorFacade - Wall Grazing C-SS2-RGBW-18L-18

40" Adjustable RGBW Linear Flood/Spot DMX Light



SPECIFICATIONS

OUTPUT

Beam Angle: 18°

Lumens: 5,250 Max. Lumen

Efficacy (lm/W): 50lm/W

LED Channels: Red/Green/Blue/White

Color Mixing: Using proprietary technology, colors are efficiently blended together through an internal mixing chamber. The one-color output reduces unsightly views of isolated Red, Green and Blue Diodes for a seamless rainbow-free appearance.

ELECTRICAL

Input Voltage: Direct 120-277V input comes standard. 50/60 Hz

Power Consumption: 0-105W

CONTROL

Interface: DMX direct via LCD display

Control System: DirectDMX Color Control. Color controlled with USITT DMX512A Standard Protocol to work with Coloronix or 3rd Party DMX Systems. On board LCD display inside the Data Enabler allow selecting of DMX addresses between 1-512 in a given DMX universe. DMX Data fed to housing via proprietary 4-wire data cable. Data Input/Output ports allow daisy-chaining of DMX Signal.

LED Die Colors: Red (620-635nm), Green (520-535nm), Blue (450-465nm) and Neutral White (5000k)

Dimming: Smooth and flicker-free dimming of all colors down to 1%

Stand Alone Control: Pre-Programmed static and dynamic scenes, as well as specific colors, can be user activated by the integral Data Enabler's computer eliminating the need for an external data source. On board OLED display inside the Data Enabler allows selection of over 30 static and dynamic color sequences. Display encased behind temperproof UV protected glass to reduce deterioration after long exposure to outdoor environments.

LUMEN MAINTENANCE

L70 Life: 35,000 Hours for ambient temperatures under 100°F.

PHYSICAL

Dimensions LxDxH: 40.4" x 6.7" x 8.8"

Housing Material: Extruded aluminum to protect light emitting diodes, other electronics and preserve optical alignment. Painted black to maximize color mixing and eliminate stray light leaks.

Weight: 16.8lbs.

Lens: Tempered Glass

Mounting: Mounting Brackets provided, one each side

Temperature Range: 14°F - 113°F Ambient

Luminaire Run Lengths: Maximum 6 units on power daisy chain, 32 units on DMX daisy chain

ENVIRONMENT

IP65

CERTIFICATIONS

ETL Listed



WARRANTY

3-Years

PHOTOMETRY

0° TILT, 4' OFFSET

FC	FC	FC	DISTANCE
1.2	2.8	1.2	100'
1.5	5.6	1.5	90'
2.0	4.6	2.0	90'
2.6	5.8	2.6	70'
3.5	7.6	3.5	60'
4.7	10.2	4.7	50'
6.5	13.4	6.5	40'
8.5	17.2	8.5	30'
7.9	16.0	7.9	20'
4.3	8.2	4.3	10'
3.5'		3.5'	

20° TILT, 15' OFFSET

FC	FC	FC	DISTANCE
11.1	22.4	11.1	50'
13.6	27.2	13.6	40'
7.6	15.2	7.6	30'
1.5	3.0	1.5	20'
1.3	2.6	1.3	10'
6'		6'	

FOOTCANDLE CALCULATION: SS2-RGBW-18L-18

Height	FC	Ø @ 50% of beam	Ø @ 90% of beam
18'	210	28'	50'
20'	168	30'	55'
24'	118	35'	67'
28'	86	42'	78'
30'	76	50'	85'
35'	56	53'	98'

INSTALLATION

The SS2 Series are active, top-of-the-line RGBW color changing fixtures that can be used in indoor or outdoor projects. They draw on solid-state elements, to produce highlights and washes in architectural spaces. RGBW is an acronym for Red Green Blue and White. RGBW LED color mixing luminaires have the potential to produce 4.3 billion colors and 16.7 million white light tones.

When installed and operated according to this manual, these fixtures will operate safely and dependably for their rated lifespan.

These luminaries require a USITT DMX 512 control signal on four consecutive channels total. The unit includes a DATA OUT output for connection to additional units or other DMX512 devices.

SCOPE

The purpose of this manual is to show proper use and installation of color-changing flood lights for peak performance. This manual must be complemented by additional references, consultation from qualified professional(s), and observance of state and local codes and regulations. This rule applies to any interior structure, exterior structure, or environment.

Therefore, it is important to: **please read and comply with all instructions and warnings in this manual when installing or using this product.**

THIS MANUAL INTENDED FOR electrical contractors, electrical engineers, and licensed electricians.

ADDITIONAL SUPPLY OPTIONS

- DMX512 compatible controller (optional)
- DMX extension (optional)
- DMX feed connector
- 4x4 inch electrical junction box rated for the application (optional)
- Controller (DMX512 compatible)
- Proper mounting bolts, washers, and lock washers to secure the fixture to the mounting surface











SAFETY HAZARD ICON KEY

 **DANGER** = avoiding *pending* danger will result in serious injury or death.

 **WARNING** = avoiding this warning may result may in serious injury or death.

 **CAUTION** = not exercising caution may result in minor to moderate injury, or property damage.

SAFETY HAZARD PRECAUTIONS

-  **DANGER:** Not turning off the main power before wiring, installing, connecting, or disconnecting this product may result in serious injury, or death.
-  **WARNING:** Not following NEC codes, local codes, or consulting a certified professional may result in property damage, serious injury, or death.
-  **WARNING:** Not following instructions or safety labels may result in property damage, or serious injury.
-  **WARNING:** Modifying, servicing, or ignoring these safety indications may void the warranty.
-  **WARNING:** Inspect product before use. DO NOT use if damaged.
-  **WARNING:** Install safety cables per local and structural engineer's code.
-  **CAUTION:** Hot swapping, not turning off fixtures before connection or disconnection, will void the warranty, and damage property.
-  **CAUTION:** Do not go beyond the specified voltage, input current, maximum number of fixtures, or run length.
-  **CAUTION:** Do not use sharp tools near the reflector or lens.
-  **CAUTION:** Do not look directly into beam, with or without optical instruments.

Note: Instructions and warning referenced in this installation guide are not necessarily all-inclusive, all conceivable, or all relevant to all applications as Coloronix by Nova Flex cannot anticipate all conceivable or unique situations.

PLANNING FOR INSTALLATION

Unpacking: Use the packing list to ensure all accessories are included. Survey the unit to make sure the data enabler/trim are all intact—not cracked or damaged. Please recycle or appropriately discard of any packing materials.

Preparation: Before Installation, we suggest:

- Consult the provided submittal drawings to recognize layouts of luminaries, power supplies, & wiring layouts
- Drawing out a layout plan consisting of locations of luminaries and wiring
- Record DMX addresses on a mapping grid for easy reference and addressing (where applicable)
- An electrical inspector reviews all wiring plans

Points to Consider About Data:

- AC Power and DATA cables may NOT run in the same conduit or within one
- foot due to possible induced errors.
- 32 DMX DATA links max per run

To Install Successfully:

1. Mount and align fixture
2. AC power connections
3. DMX connections

SETTING COLOR MODE

For installations requiring DMX control, set the personalized DMX address on the LCD menu (pictured at right) using the address table below.

Note: Up to 128 unique 4-channel addresses can be set per DMX universe. The factory default setting for this unit is 4-channels.

Lock Function: If MENU is IDLE for 20 seconds, MENU will lock. Hold MENU and “DOWN” button to release lock.



DMX Mode

1. Press the “MODE”, enter the DMX mode “d.x××”.
2. Press the “UP” or “DOWN”, set up the DMX address value d.001-d.512
3. Press the “SETUP”, enter the DMX working mode: X-ch
4. Press the “UP” or “DOWN”, set up the DMX working mode to Mode 1

DMX Working Mode 1: 4-CHANNEL (for individual color dimming control)

Channel	Value	Function
CH1	0-255	Red
CH2	0-255	Green
CH3	0-255	Blue
CH4	0-255	Cool White

Pre-Programmed Mode (**Static Color**):

1. Press “MODE”, enter the mode “Prxx”
2. Enter Pr.01
3. Press “SETUP” and toggle between static color to achieve desired show

No.	Color
1	Red
2	Lime Green
3	RGBW
4	Green
5	Light Blue
6	Blue
7	Purple
8	Magenta
9	Bright White
10	Pink
11	Light Green
12	Light Purple
13	Orange
14	RGBW

Pre-Programmed Mode (**Show Mode**):

Pr.01	Static color program
Pr.02	Four colors fading
Pr.03	Ten color fading
Pr.04	Four color dream
Pr.05	Four color hopping
Pr.06	Ten color hopping
Pr.07	Red fading
Pr.08	Green fading
Pr.09	Blue fading
Pr.10	White fading

NOTES:

- Please follow the user manual to ensure safe installation and operation.
- To prevent overheating, please use within the acceptable ambient temp range listed in specs
- Do not take down the light while it's plugged in.

MOUNTING AND ALIGNMENT OF FIXTURE

1. Mount and secure each fixture into the designated position in accordance to the installation plan. Ensure there is sufficient cable length between the fixture and junction box to allow for final alignment of the fixture.
2. Secure the fixtures to a solid mounting surface using three threaded fasteners minimum of 3/8 inch (10mm) stainless steel complete with flat and locking washer.
3. Rotate/tilt the fixture into the desired position.

- DMX SIGNAL 4-wire Data Cable **C-SWR-DMX-WL-80 or 300**
- POWER **C-SWR-PWR-WL-80**

NOTES

- Colors can be controlled directly on lights. Subsequent lights should be set to SLAVE mode to mimic Master light
- Max 32 fixtures per data feed
- Longer lengths between fixtures available

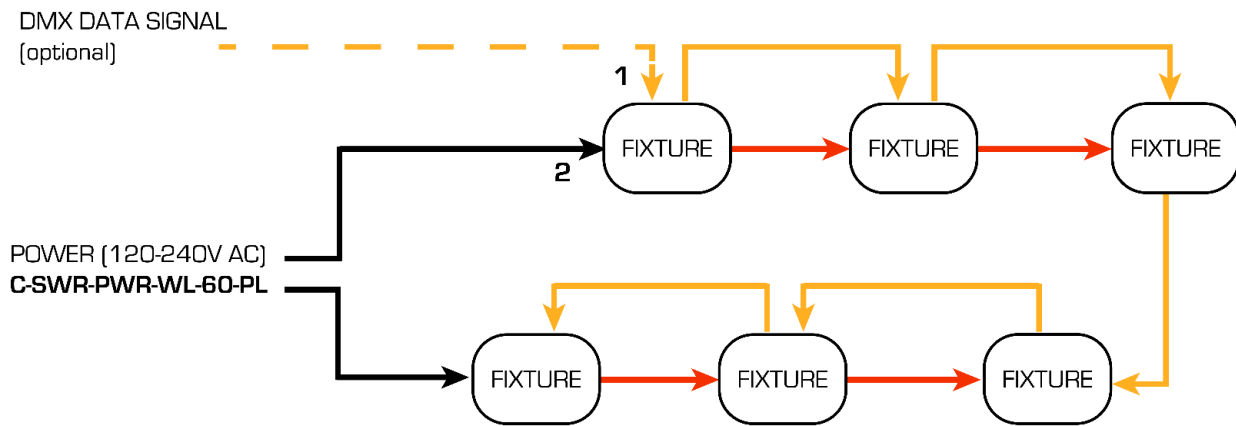

4-PIN INTERFACE		
Pin 1	+	Line Voltage
Pin 2	-	Neutral
Pin 3	Shield	Ground
Pin 4	Reserved	Leave Open

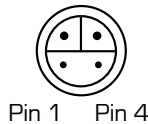

REQUIRES ELECTRICIAN TO INSTALL

NOTE: Supply lead wires should not be connected to a dimmer of any sort.

DATA CONNECTION

- Inline DMX amplifier required if run length exceeds: 125 feet between fixtures (others)
- Maximum run length from DMX controller to last fixture: 1000 feet
- DMX must be continuous from controller to last fixture in a run. A splitter is needed if signal is split
- If provided data cables won't be used, please note that any cables must meet EIA-RS485 requirements and warranty may be voided
- To comply with all local codes and jurisdiction, qualified communications technicians must do communications wiring
- To avoid signal transmission problems and interference, it is always advisable to connect to a DMX signal terminator
- Communication cables and AC power lines must not be run in the same conduit
 - Route Data Cables in series between fixture and any communications accessories using DATA IN and DATA OUT
 - To ensure they are easily accessed once construction is complete, secure data cables near the fixtures

MAINTENANCE

We recommend periodic cleaning. Over time these components can become dirty or full of debris. This can result in lack of cooling or can limit the capabilities of the fixture. **Lens:** Clean the front Lexan® as required using window cleaner or mild soap and water. Dry with a quality paper towel to avoid scratches or streaks. **Mounts/Fasteners:** Check annually for tightness and security to avoid damage to the fixture and possible liability.

TROUBLESHOOTING

If problems occur during usage, unplug the product immediately and email support@novaflexled.com or call 800-595-6302.

Replacing a Failed Fixture: "Hot Swapping" a fixture is not allowed. If a fixture needs to be replaced, the steps are to:

1. Disconnect the DMX **input** at the junction box of the fixture needing replacement, THEN disconnect DMX **output**
2. Replace fixture
3. Reconnect AC **negative**, THEN AC **positive**
4. Reconnect DATA **output**, THEN DATA **input**
5. Reconnect power and make sure the replaced fixture and the entire system is in working order

If fixture does not light, check if:

- Electrical power is not connected.
- Electrical power is less than specific voltage.
- Electrical power is greater than specified voltage.

If fixture does not respond to DMX control signal, check if:

- DMX control device and RGBW are addressed differently.
- DMX cable is damaged.
- DMX control device is disconnected or not operating.
- DMX device needs to be restarted.
- LED fixture was not restarted after address change.
- Restart fixture.

If the fixture is not responding to DMX, check if:

- DMX addressing is incorrect: Check Control Panel and unit addressing.
- The wrong polarity settings may be on the controller: Check polarity switch settings on the controller.
- DMX cables may be loose: Check cable connectors.

If DMX control operation flickers or is intermittent, check if:

- RGBW fixture or final DMX device in daisy chain is not terminated.
- DMX cable is damaged.
- DMX control device is operating at less than 25Hz.

If there is a loss of signal, check if:

- Non-DMX cables are being used: Use only DMX compatible cables
- Signals are bouncing: DMX terminator is not installed as suggested.

If output is less than normal, check if:

- Environment temperature may be in excess of 114°F/45°C.
- Lens may be damaged or dirty.
- DMX control or RGBW channels may be set at low level.

View [Nova Flex Terms & Conditions](#) for more details.