

RESOURCE GUIDE - POWER & CONTROL

WALL MOUNT RGB/W DIM | S3i

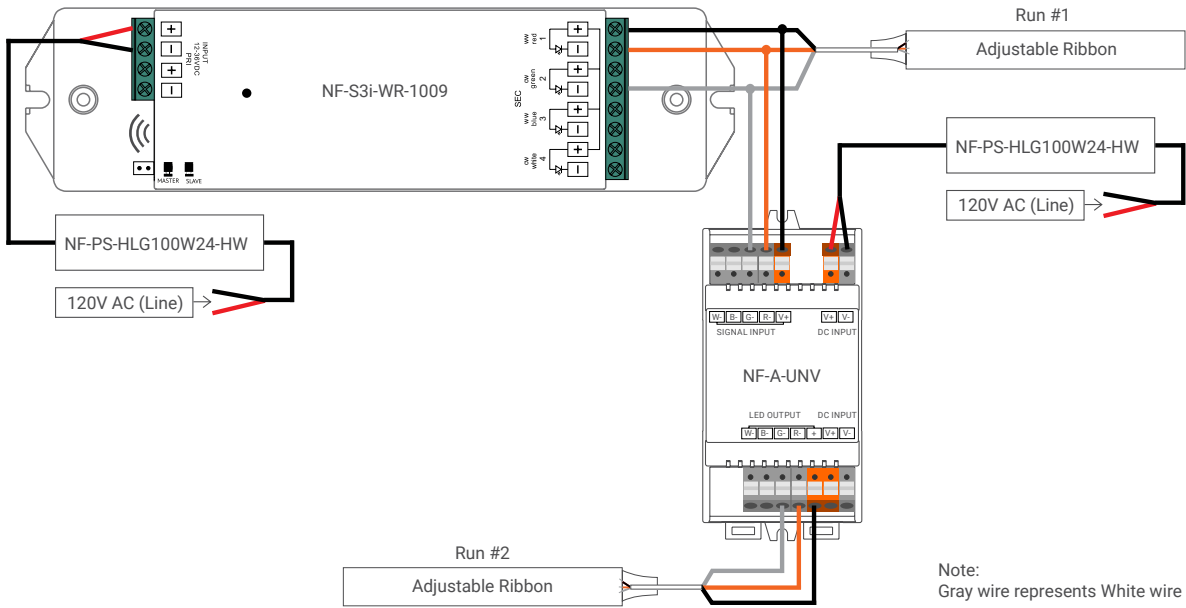

WIRING



PAIRING

Remove plastic battery saver within the controller to operate. Once NF-S3i-WR-1009 is discoverable, press the ON button on controller (flash indicates pairing successful)

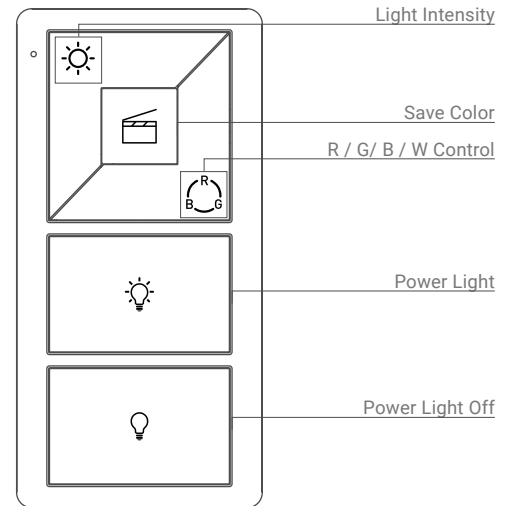
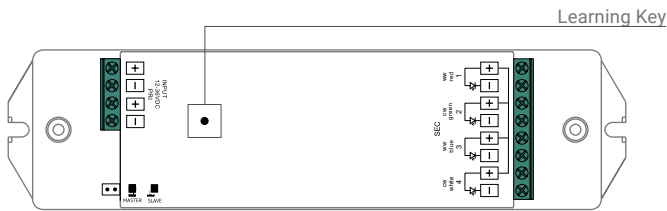

Nova Flex LED, LLC. retains the right to modify the design of our products at any time as part of the company's continual product improvement program.



RESOURCE GUIDE - POWER & CONTROL

WALL MOUNT RGB/W DIM | S3I



OPERATION

Controlling Zones - Up to 4 different ZONES
Scene - NO SCENES

Color Change - RGB
Press and Hold R/G/B Cycle button  to change color (only goes one direction).
Press R/G/B Cycle  once fast to change to Preset SOLID Colors (repeat to cycle through all Preset Colors).

Color Change - White
Press the "W" once fast to Turn ON WHITE (Press W once fast again to Turn OFF)
To change to solely WHITE, DOUBLE TAP R/G/B Cycle button  TWICE FAST to turn OFF colors. Then press W once fast to turn ON WHITE (press W once fast again to turn OFF)

Brightness - RGB
Press and hold Sun  (Top Left) to adjust brightness (release button and press and hold again to go opposite direction). Also works when mixing R/G/B/W colors!

Brightness - White
Press and hold W to adjust brightness (release button and press and hold again to go opposite direction). Also works when mixing R/G/B/W colors!