

RESOURCE GUIDE - POWER & CONTROL

STATIC TOUCH PANEL | S3I

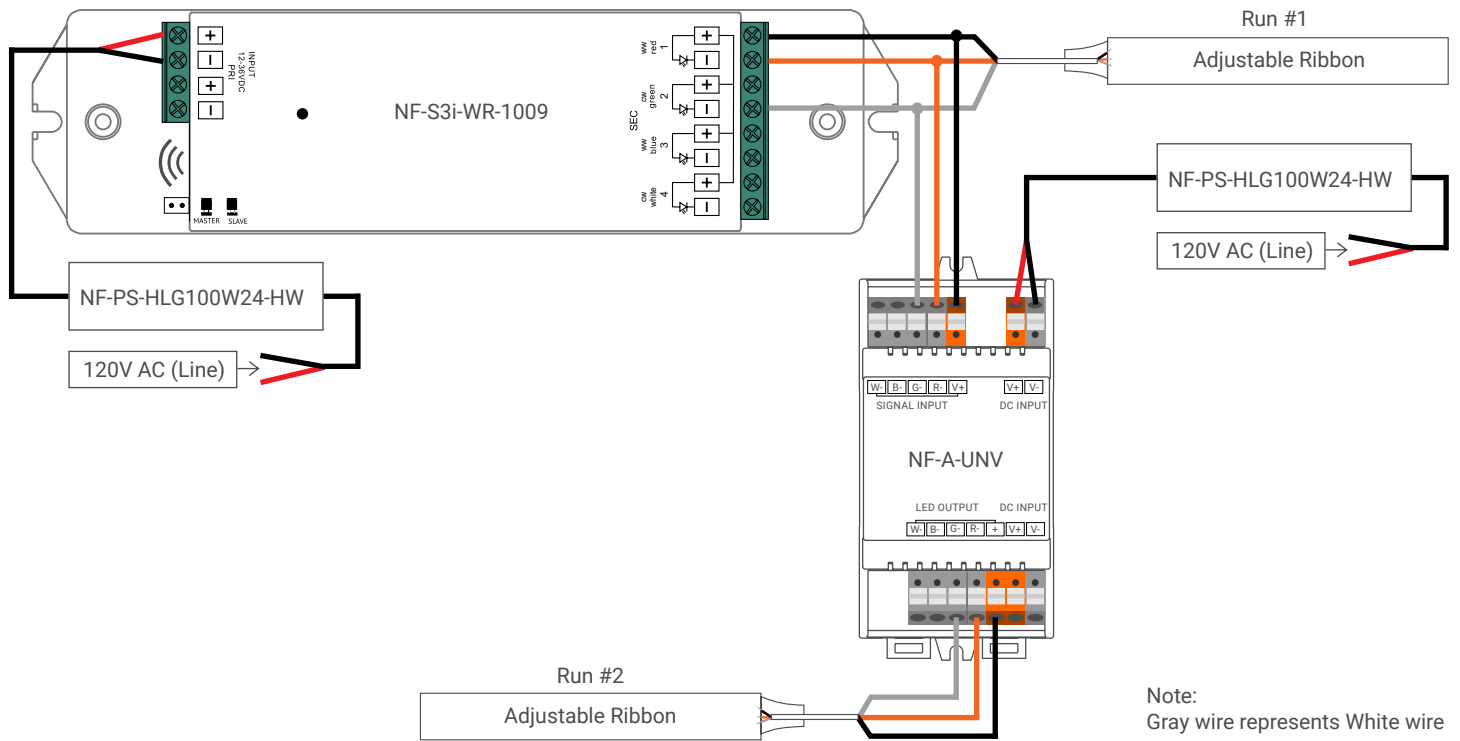

WIRING DIAGRAM



PAIRING

Turn on the Touch Panel (Indicator light will turn BLUE).
 Click the Learning Key on the NF-S3i-WR-1009.
 Select your "ZONE" (Z1, Z2, Z3, Z4) then play with color panel.

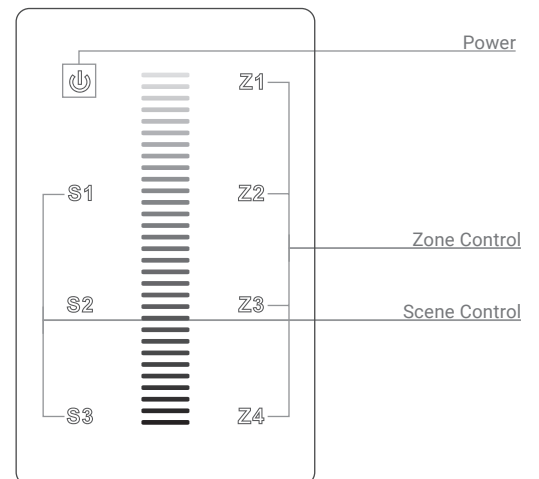
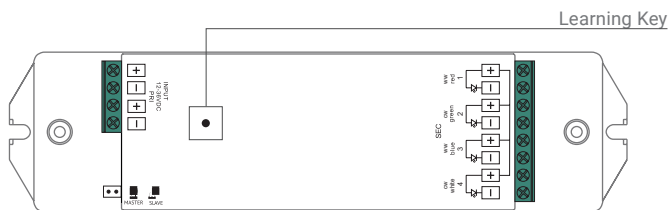

Nova Flex LED, LLC. retains the right to modify the design of our products at any time as part of the company's continual product improvement program.

RESOURCE GUIDE - POWER & CONTROL

STATIC TOUCH PANEL | S3I



OPERATION

Controlling Zones - Up to 4 different ZONES

Refer to "Pair" above to pair different zones. Once zone is paired, select the "ZONE" you'd like to control.

Once zone is paired, turn on the remote and select the "ZONE" you'd like to control.

You can easily control MULTIPLE ZONES at once by selecting ALL ZONES in continuous form that you'd like to control. Ex: to control 1, 3, and 4, click Z1, Z3, Z4, one after another then move finger on color wheel. All zones 1, 3, 4 are now being controlled at the same time.

To get OFF this mode, simply Select a specified ZONE after a few seconds you'd like to control.

Turn ON/OFF a single Zone

Press and Hold ZONE number you'd like to turn ON/OFF

Turn ON/OFF ALL Zones

Press the "Power" button (BLUE = ON ; GOLD = OFF)

Setting Scenes - Up to (different Scenes total

Adjust light to scene you would like to save.

Press and hold "SCENE" number for 3 seconds (lights should flash when stored successfully)

Color Change

Select the ZONE(s) you'd like to control. Select the Half Color Moon (BLUE/GOLD) Half Dark Moon (BLACK/WHITE) on the LEFT hand side of the Touch Panel (GOLD = COLOR CHANGING MODE). Then use Color Panel to adjust Color.

Brightness

Control with Color Panel